

Haier

Heat Pump Water Heater Operation and Installation Manual

Model

HP300S2-F7

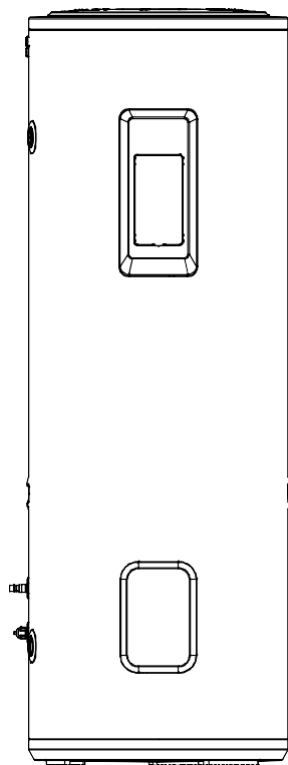
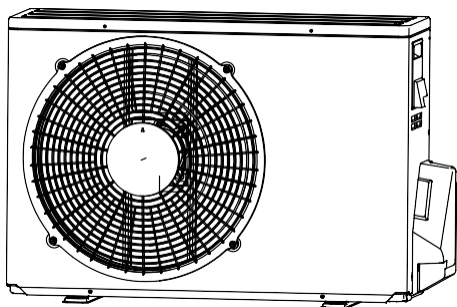

Please read this manual carefully prior to your use of this water heater. The appearance of the water heater shown in this manual is for reference only.

Contents

1. Safety Instructions	
2. Instructions on transportation and storage	3
3. Functions & principles	6
4. Technical parameters	7
5. Description of parts and components	8
6. Installation instructions	11
7. Operation and functions.....	25
8. Precautions for flammable refrigerant	30
9. Checking and maintenance.....	36
10. Faults and protection	37

Dear users of Haier,

Thank you for choosing Haier products.

Please read this manual carefully and follow the operation and safety instructions to ensure the best installation and utilization of the product.





Product safety statement:







1. The appliance must be installed by qualified professional. The appliance must not be used by persons (including children) with reduced physical, sensory or mental capabilities, or lack of experience and knowledge, unless are supervised. Cleaning and user maintenance shall not be carried out by children.
2. Children shall be closely supervised to make sure they stay away from this product.
3. The pressure temperature relief valve (PTR valve) must be installed according to the "Pipeline installation diagram".
4. A discharge pipe connected to the PTR valve is to be installed in a continuously downward direction and in a frost-free environment.
5. The water may drip from the PTR valve drain and that this pipe must be left open to the atmosphere.
6. DANGER: The PTR valve lever should be activated every six months to remove lime deposits and to verify that it is not blocked. Failure to do so may result in the water heater exploding.
7. Continuous leakage of water from the PTR valve may indicate a problem with the water heater or valve.
8. The water heater is to be drained according to the instructions specified on page 19.
9. Since the Max. inlet water pressure is 500 kPa, a pressure limiting valve must be installed according to the "Pipeline installation diagram".
10. DANGER: The operation of the thermal cut-out indicates a possibly dangerous situation. Do not reset the thermal cut-out until the water heater has been serviced by a qualified person.
11. The appliance is intended to be permanently connected to the mains water with an inlet pressure of 100kPa to 500kPa.

Safety instructions (to be followed at all times)

Interpretation of marks and symbols

Failure to follow these instructions may lead to serious appliance malfunction and risks harm to the user.

	<p>Instructions with this warning mark shall be strictly followed during operation. They relate to the safety of users.</p>
	<p>Information provided with this banning mark relates to activities that are forbidden. Otherwise, the appliance may be damaged, and the users may risk serious personal danger.</p>

  <p>The water heater shall be installed in strict accordance with local electrical regulations. The power supply must have an earth wire. Ensure an effective earth connection.</p>	 <p>Ground (earth) and neutral lines of the power supply must not connect at any time. The ground (earth) line shall not be connected to gas or water pipes, lightning arresters, or telephone lines.</p>
 <p>The water heater must be installed in a location where suitable water drainage is possible.</p>	 <p>Children must not play with the appliance.</p>
 <p>This appliance must be fitted with the pressure and temperature relief valve (PTR valve) supplied with the appliance. The PTR valve must be fitted directly to the appliance.</p>	

Safety instructions (to be followed at all times)

<p>⚠</p> <p>The outlet water temperature of a water heater may be higher than the temperature indicated on the display. Ensure that contact with hot water directly leaving the appliance cannot occur.</p>	<p>⚠</p> <p>This appliance must be installed with an isolation switch to the power supply. This switch must ensure full disconnection and be in accordance with the wiring regulations.</p>
<p>⚠</p> <p>Install the water heater in strict accordance with the installation instruction specified on pages 11-23 of this manual.</p>	<p>⚠</p> <p>If the electrical power cord is damaged, it shall be replaced by a qualified professional.</p>
<p>⚠</p> <p>Do not put your hands or other items into the air grid. This may cause injury or damage to the appliance.</p>	<p>⚠</p> <p>Maintenance shall be carried out according to the instructions specified in this manual.</p>
<p>⚠ The water heater must be installed: - by licensed trades people. in accordance with all local codes and regulations and standards including AS/NZS 3500.4 and AS/NZS 3000.</p>	
<p>⚠ Warning: -For continued safety of this appliance it must be installed, operated, and maintained in accordance with the manufacturer's instructions.</p>	
<p>⚠ Warning: - This appliance's delivery temperature may be more than 45°C. At higher temperatures, please refer to the plumbing codes of New Zealand and Australia (PCA), and any local requirements and installation instructions to determine if additional delivery temperature control is required.</p>	

Safety instructions (to be followed at all times)



The PTR valve must be operated every six months to remove lime deposits and ensure it is free from blockages.



Water heaters shall be equipped with a dedicated power line and residual current circuit breakers. The trip current shall not exceed 15mA.



The PTR valve drain must be installed in a continuous downward direction, be open to the atmosphere, be free from blockages, and the potential of freezing.



Refrigerant: R32; When handling this product, you should

- Ensure no smoking occurs in the area.
- Prevent the possibility of electrostatic discharges.
- Keep the work area well ventilated.
- Avoid contact of the refrigerant to the skin and eyes.
- Prevent inhalation of refrigerant vapors.
- Ensure no non-essential people are in the area.
- Prevent any refrigerant leaks during installation.



The appliance contains fluorinated greenhouse gases.

Chemical name: R32

Fluorinated greenhouse gases are contained in hermetically sealed equipment.

Any electrical switchgear should have a tested leakage rate of less than 0.1 % per year as set out in the technical specification of the manufacturer.

The expressed equivalent weight in CO₂ of R32 gas is GWP 675.

Instructions on transportation and storage

1. During transportation or storage, the heat pump water heater should remain in its packaging. This will prevent possible damage to appearance and performance of the product.
2. During transportation or storage, the heat pump unit and the cylinder should remain in the upright position.



The heat pump unit must remain in the upright position at all times for the best performance!

WARNING:

IF THE HOT WATER SYSTEM IS NOT USED FOR TWO WEEKS OR MORE, A QUANTITY OF HIGHLY FLAMMABLE HYDROGEN GAS MAY ACCUMULATE IN THE WATER HEATER. TO DISSIPATE THIS GAS SAFELY, IT IS RECOMMENDED THAT A HOT TAP BE TURNED ON FOR SEVERAL MINUTES OR UNTIL DISCHARGE OF GAS CEASES. USE A SINK, BASIN, OR BATH OUTLET, NOT A DISHWASHER, CLOTHES WASHER, OR OTHER APPLIANCE. DURING THIS PROCEDURE, THERE MUST BE NO SMOKING, OPEN FLAME, OR ANY ELECTRICAL APPLIANCE OPERATING NEARBY. IF HYDROGEN IS DISCHARGED THROUGH THE TAP, IT WILL MAKE AN UNUSUAL SOUND LIKE AIR ESCAPING.

Functions & principles

A low-pressure liquid refrigerant is vaporized in the heat pump's evaporator and passed into the compressor. As the pressure of the refrigerant increases, so does its temperature. The heated refrigerant runs through a condenser coil within the storage tank, transferring heat to the water stored there. As the refrigerant delivers its heat to the water, it cools and condenses, and then passes through an expansion valve where the pressure is reduced, starting the cycle over-again.

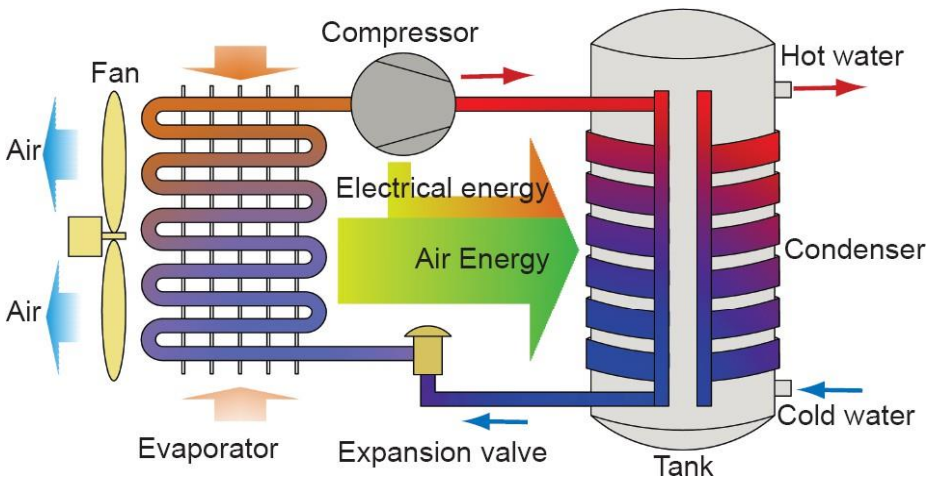

Technical parameters

Model number (system)	HP300S2-F7
Model number (cylinder)	THP300S2-F7
Model (heat pump unit)	EHP50S2-F7
Cylinder volume	276L
Rated voltage/frequency	220V~240V/50Hz
PTR Valve setting	700kPa
Inlet water pressure	100kPa ~ 500kPa
Corrosion protection	3 x Magnesium rods
IP rating	IPX4
Assembled System	
Rated total power	4.3kW
Maximum power input of heat pump	1.7kW
Average power input of heat pump	1.19kW
Power input by electric element	2.6kW
Default temperature setting	55°C
Temperature setting range (with heater)	35°C-75°C
Maximum length of refrigerant pipe	3m
Max working pressure of refrigerant	4.5MPa
Refrigerant type/weight	R32/930g
Sound pressure level (@ 1m)	52dB(A)
Ambient temperature range (product)	-15°C~45°C
Operating temperature range (heat pump)	-15°C~45°C
Dimension and connections	
Water inlet and outlet connection	R3/4"
Safety valve connection	R3/4"
Drain connection	R3/4"
Product dimension (tank unit)	(622*580*1694)mm
Product dimension (heat pump unit)	(780*286*545)mm
Packaging dimension (tank unit)	(687*717*1832)mm
Packaging dimension (heat pump unit)	(917*348*597)mm
Net/Gross weight (tank unit)	86/97kg
Refrigerant pair-coil sizes	1/4"(6.35mm) – 3/8"(9.52mm)
Refrigerant connections	7/16-20 UNF – 5/8-18 UNF
Net/Gross weight (heat pump unit)	30/33kg
* The COP and noise level data was tested in Haier lab.	

Description of parts and components

Heat pump structure

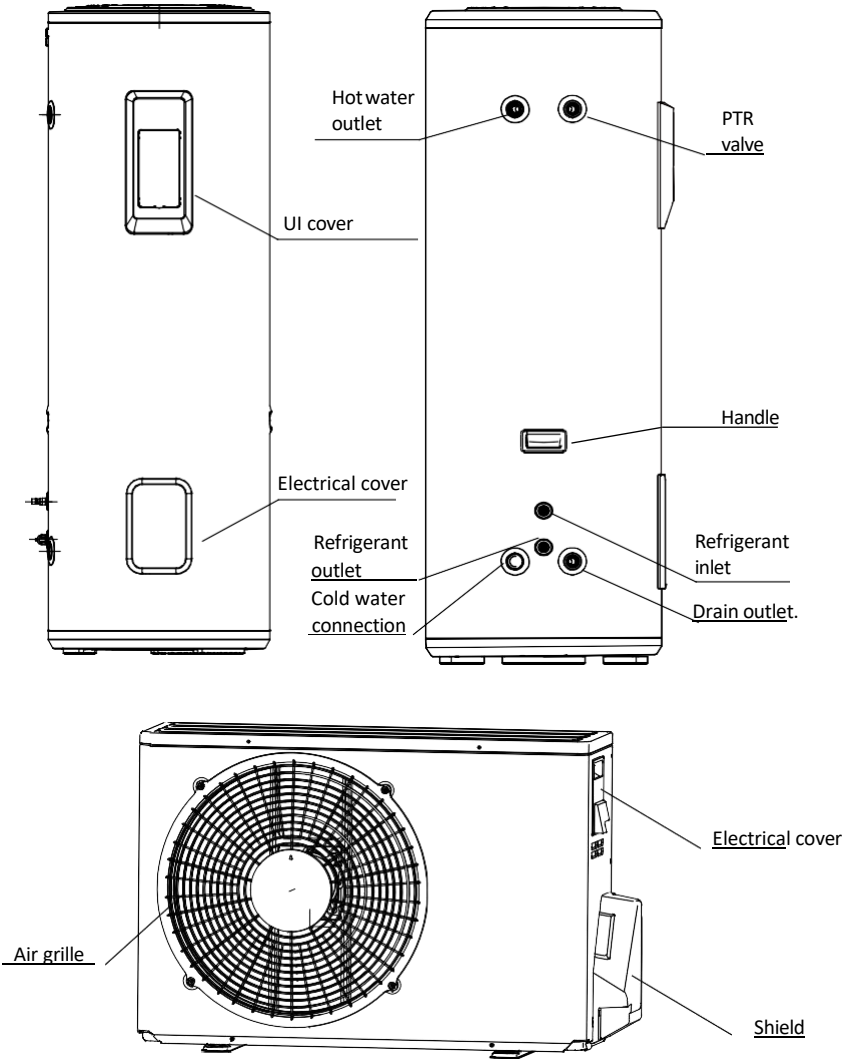

HP300S2-F7

Description of parts and components

Exploded view (tank unit)

S/N	Description
1	Service lid
2	Temperature controller
3	Water tank temperature sensor
4	Seal ring
5	Back shell of wire controller
6	Display plate rear shell
7	Display plate front shell
8	Front shell of wire controller
9	Display panel cover
10	Electric heating element
11	Electrical room rear housing
12	Electrical room front shell

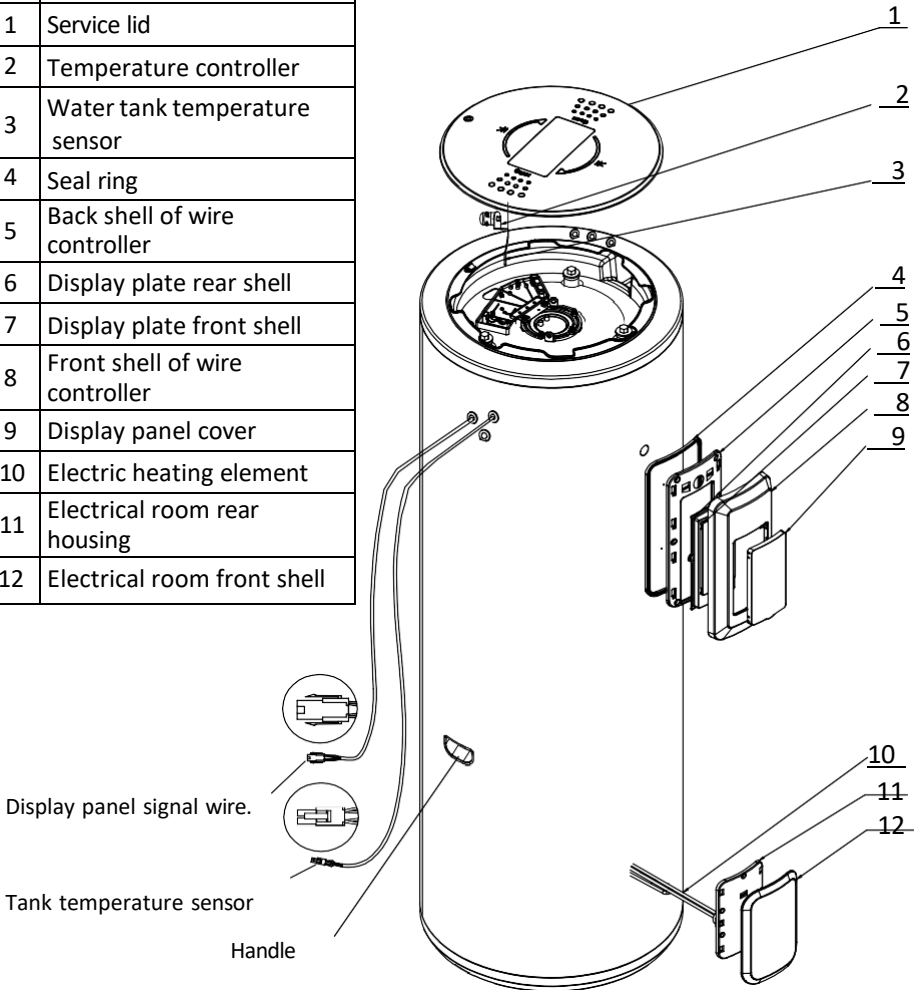

Accessories (tank unit)

Part name	Cylinder	PTR valve	Instruction manual	Supply cable	Tamper-proof buckle	Interconnection Cable
Quantity	1	1	1	1	1	1

Description of parts and components

Exploded view (heat pump unit)

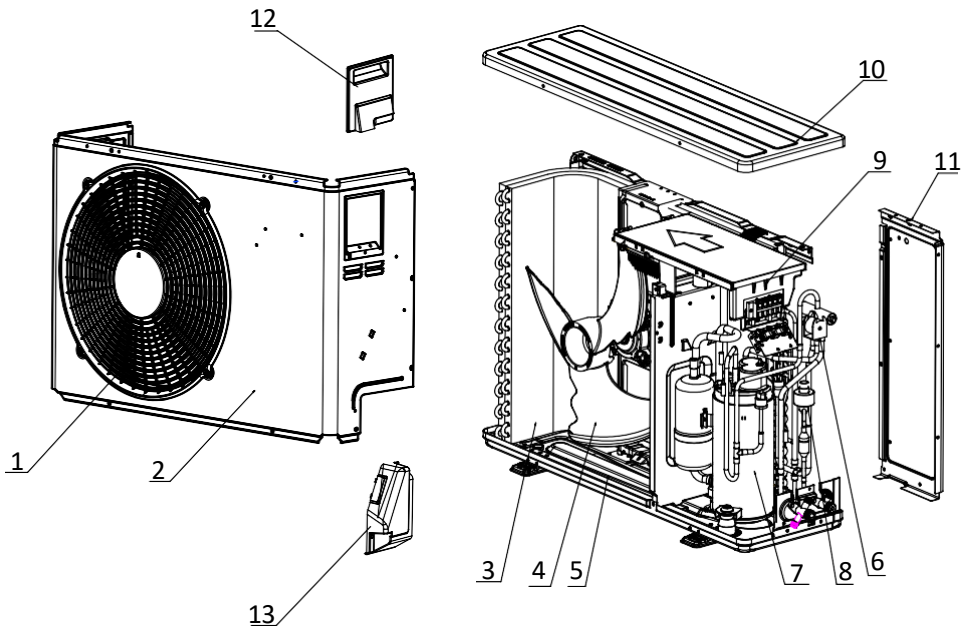

S/N	Description
1	Air grille
2	Front cover
3	Evaporator
4	Fan
5	Bottom Cover
6	Four-way valve

S/N	Description
7	Compressor
8	Expansion valve
9	Controller panel
10	Top Cover
11	Right Cover
12	Handle
13	Shield

Accessories (heat pump unit)

Part name	Heat pump unit	Condensate drain	Drain elbow	Wrapping tape	Packing list	Through the wall retainer
Quantity	1	1	1	1	1	1

Installation instructions

Installation precaution

- Do not install the water heater in a location that exposes it to gas, vapors, or dust.
- Install the cylinder and heat-pump unit on a flat, solid surface. The surface or base must be able to support the weight of the appliance, and condensate must be able to drain freely.
- Locate the appliance in an area where noise and air flow from the appliance does not bother the homeowner or neighbours.
- Make sure there is sufficient space around the appliance for its installation and maintenance.
- Ensure there is no strong electromagnetic interference that may affect control functions of the appliance.
- There is no Sulphur gas or mineral oil in the installation area which may cause corrosion of the machine and the fittings.
- Install water pipes to ensure that they cannot fall below 0°C shall and freeze.
- The heat pump unit must be installed outside. The cylinder can be installed inside or outside the home.
- The optimum ambient air temperature to run this appliance is 10°C to 35°C. The appliance will still operate well outside of this range, but at a reduced capacity.
- Discharge of condensate: The condensate or water, which is formed in the heat-pump unit during heating must be drained. The condensate drain connection is located at the bottom of the heat-pump unit. Ensure the condensate drain has a continuous downward direction and is free from blockages.

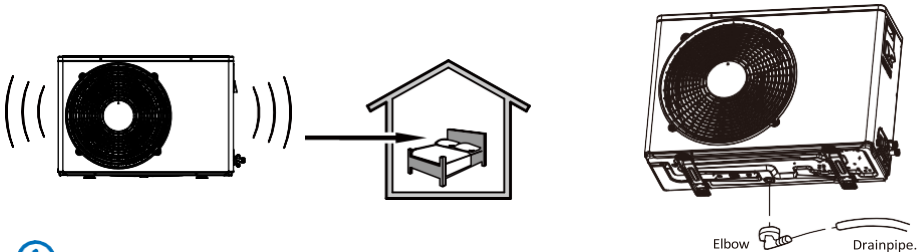

Keep an adequate distance between the working heat pump and bedrooms and quiet areas.

Installation instructions

Installation dimensions

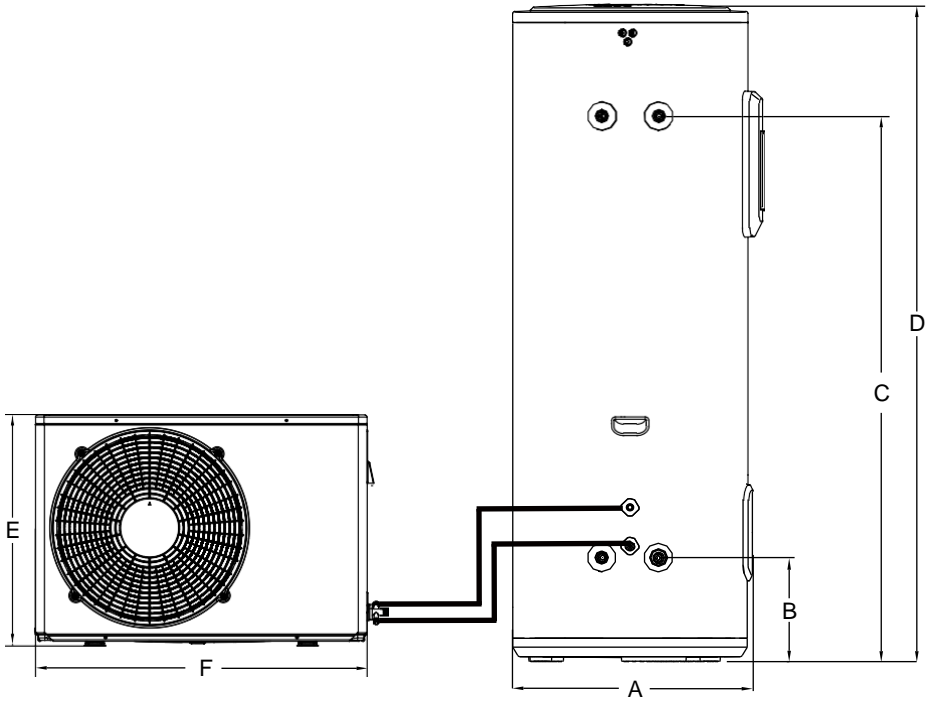

Unit: mm

Model	A	B	C	D
THP300S2-F7	593	268	1410	1694

Model	E	F
EHP50S2-F7	545	780

Installation instructions

Installation clearances

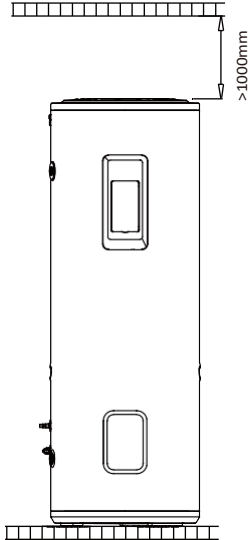
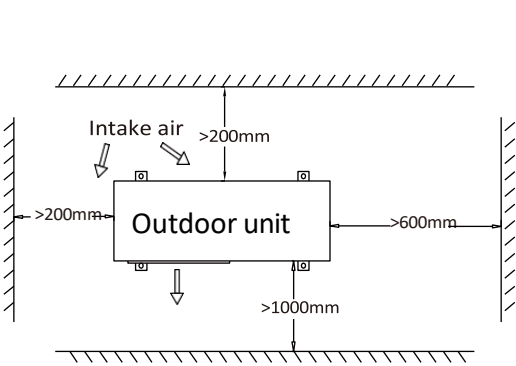

Installation instructions

Tools for the connection of refrigerant lines

- a) Group manometer suitable for use with R32, with charge and vacuum tubes.
- b) Vacuum pump.
- c) Torque wrenches for nominal diameter of 7/16-20UNF and 5/8 -18UNF sizes on both sides to respond to the measures of the pipe unions.
- d) Flaring clamp \varnothing nominal 7/16-20UNF and 5/8 -18UNF, equipped with a terminal receiving opening so that the projection of the copper tube can be adjusted from 0 to 0.5 mm in the working folder.
- e) Pipe cutter;
- f) Pipe reamer.
- f) Leak Detector for R32, a leak detector is used exclusively for HFC refrigerants. It must have a high detection sensitivity.

Preparation of the refrigerant pipework

WARNING! Before carrying out any installation check the following:

- a) Use only copper tubes suitable for refrigeration appliances such as air conditioners and be suitable for use with R32.
- b) Always use locally compliance refrigerant pair-coil.
- c) Provide the shortest, simplest path possible between the heat pump unit and the cylinder.
- d) Ensure that the refrigerant pipework will not obstruct access to the cap and the removal of flange.
- e) Secure and protect the pipework and cables to avoid damage.

WARNING! The refrigerant lines, and fittings for connection must be insulated to avoid dangerous burns, loss of performance and product malfunction. Ensure that the insulating sheath is fastening with clamps to prevent it from moving.

Installation instructions

Connecting the tank unit

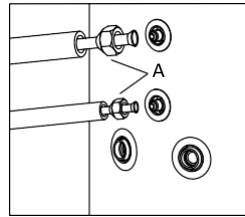
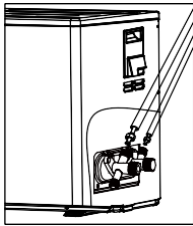
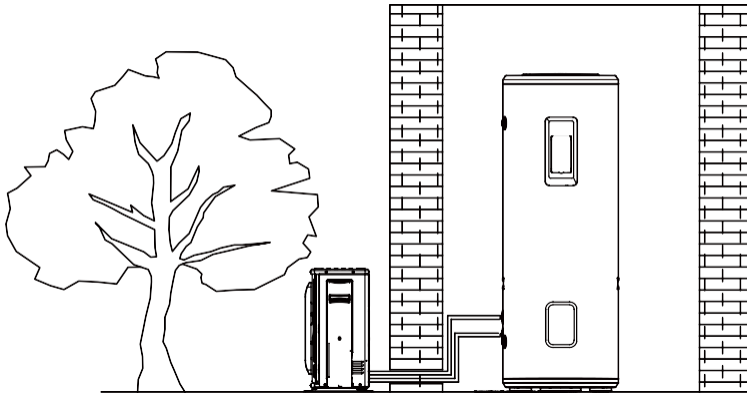

- Shape the pipes according to the route required.
- Remove the threaded brass flare nuts(A) on the tank unit and store them.
- Check that the pipes and fittings are clear of impurities.
- Cut the pipe to the fixed length using a pipe cutter and avoiding any deformation.
- Remove any pipework burrs with pipe reamer ensuring not to leave impurities inside the pipe.
- Install the threaded brass flare nuts(A) on the pipes in the correct direction.
- Insert the tube into the flaring tool. Flare the end of the pipe as indicated in the table.

Connection	Pair-coil	Connection
Inlet refrigerant pipe	1/4" (6.35mm)	(7/16-20UNF)
Outlet refrigerant pipe	3/8" (9.52 mm)	(5/8 -18UNF)

After confirming that there are no wrinkles or tears on the flare, connect the pipes using two spanners, being careful not to damage the pipes. If the force is insufficient the seals may not be made, causing leaks. If the force is excessive, damage to the flange may occur. The safest method is to carefully tighten the connection by using 2 spanners.

Installation instructions

Connecting the heat pump unit



When making the connections, follow local standards and regulations.

Remove the caps from 2- and 3-way valves. Fit the flare nuts of the pump onto the on the pipes, screw the flare nuts to connect the heat pump unit with the same method described for the cylinder.

Vacuuming the appliance

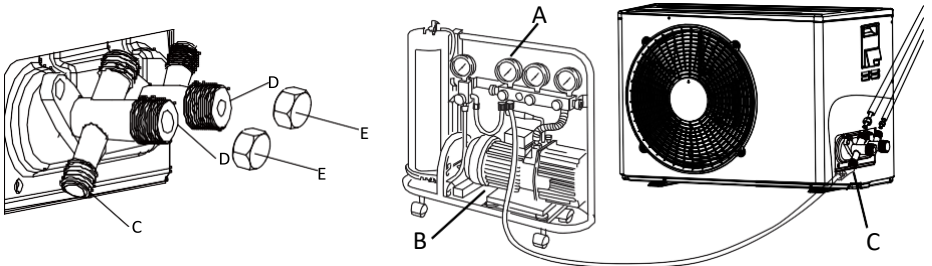

Vacuuming the system with a vacuum pump and pressure gauge assembly suitable for R32.

Make sure the vacuum pump has the correct oil level indicated by the oil gauge.

- Loosen the 2- and 3-way valves and the service valve. Check that the two valves on the heat pump unit are closed (D).
 - Connect the vacuum pump (B) to the service valve (C) by attaching a low-pressure gauge (A).
 - After opening the valves on the vacuum pump (B), start the pump, and let it run. Create a vacuum for about 20 to 25 minutes.
 - Verify that the low-pressure gauge (A) indicates a pressure of 1 bar-(or -76 cm Hg).
 - Close the valves of the pump and shut off (B). Verify that there is no change in pressure over 5 minutes.
- If the needle moves, there are leaks in the system. Check the flare joints, remake if required, and then repeat the procedure from step C.
- Disconnect the vacuum pump.
 - Completely open the taps on 2- and 3-way valves (D).
 - Screw in the cap on the service outlet and valves (E).
 - After tightened the connections, make sure there are no gas leaks using the appropriate detector.



Always protect pipes, hoses, and cables from damaged. Damage to these components can cause gas leaks.

Installation instructions

Charging the appliance

If you are adding R32 gas in the circuit, you will need:

- Electronic scales for refrigerant charging with sensitivity 1g.

During installation:

- a) Connect the manometer to the low-pressure service valve and connect the refrigerant cylinder to the center tap of the manometer. Open the valve of the refrigerant container, then open the main valve cap pressure gauge and adjust the needle valve until a leak can be heard. Release the pin and close the valve of the pipe.
- b) Monitor the refrigerant tank weight using the electronic scale.
- c) Open the ball valve to allow refrigerant to gradually enter the appliance.
- d) After reaching the correct mass of refrigerant, close the tap.
- e) Remove the manometer and charging hose from the valve.
- f) Fully open the 2- and 3-way valves (D), turn the product in heat pump mode and using the detector check for leaks.
- g) Remove the refrigerant container from the manifold and replace all plugs (E).

For an existing installation:

- a) Connect the manometer on the low-pressure service valve. Connect the refrigerant cylinder to the center tap of the manometer. Open the container of refrigerant then open the main valve on the pressure gauge. Adjust the needle valve until you hear the refrigerant leak and release the pin and close the valve of the pipe.
- b) Monitor the weight of the refrigerant tank through the electronic scale.
- c) Open the ball valve allowing the refrigerant gradually flow into the appliance.
- d) After reaching the mass of refrigerant, close the tap.
- e) Remove the manometer and charging hose from the valve.
- f) With the detector and check for leaks of refrigerant.
with the detector and check for leaks of refrigerant.
- g) Remove the container from the manifold and replace all the plugs (E).
- h) Once the appliance is charged, verify the appliance functions properly.

Installation instructions

Plumbing installation



Plumbing installation must be compliant with AS/NZS3500.4 and the Plumbing Code of Australia (PCA).

1. The plumbing connections for this appliance must be installed:
 - a. by licensed trades people.
 - b. in accordance with all local codes and regulations and standards including AS/NZS3500.4, AS/NZS 3000, and the Plumbing Code of Australia (PCA).
2. The inlet water pressure must be between 100kPa – 500kPa.
3. Inlet water connections: An isolating and non-return valve must be installed on the inlet to the appliance. If the supply pressure could exceed 500kPa, a pressure limiting valve must be installed on the cold-water inlet. If a cold-water expansion control valve (ECV) is required by local regulations, a valve of a maximum of 600kPa can be fitted. The correctly sized pressure limiting valve should also be fitted as per the ECV manufacturers specifications.
4. If no ECV is fitted, a pressure limiting valve of a maximum of 500kPa should be fitted.
5. The cold-water inlet to the appliance must have a line filter, non-return valve and isolating valve fitted. Combination valves of these functions are also suitable.
6. Outlet water connections: A thermostatic mixing or tempering valve must be used when hot water is supplied to fixtures used for sanitary use (i.e. Bathrooms) according to AS/NZS 3500.4 requirements.
7. For ease of assembly and disassembly of the appliance, it is recommended that mechanical joints are used to connect to the water heater.
8. The water inlet and outlet pipes must be fitted to as per the labels at the hot and cold-water connections.
9. To avoid damage on the appliance, the inlet water temperature should remain between 10°C to 40°C.
10. Before filling the tank, make sure that the cold-water inlet and hot-water outlet of the appliance is open, along with the farthest hot water fixture. The appliance will be correctly filled once water flows continuously from this fixture without air bubbles. Venting through the PTR could cause premature failure of the valve.
11. If there is a risk of freezing, hot-water pipes, cold-water pipes, valves and drain lines connected to the appliance must be insulated with 20mm insulation. Failure to adhere to this may result in a voided warranty if damage due to freezing occurs.
12. In accordance with safety rules, a PTR valve (700kPa, 99°C, Rp3/4”) must be installed directly into the PTR valve connection on the appliance. Never block the outlet of the safety valve or its drain line for any reason.

Installation instructions

Pipeline installation diagram

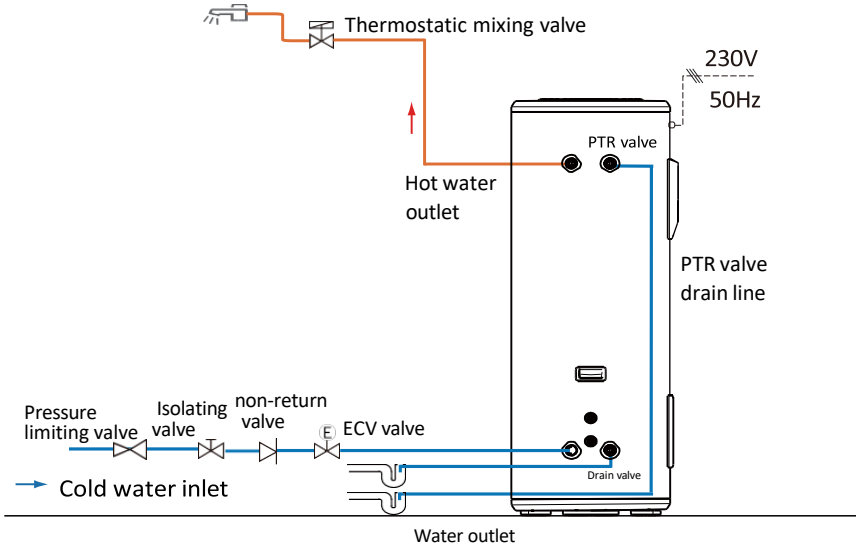

Note: The correct pressure temperature relief PTR valve is supplied with this appliance.

- The thermostatic mixing valve, check valve, non-return valve and pressure limiting valve are not supplied with this product. Please source in local market.
- A 20mm 700kPa PTR valve must be installed with this appliance.
- A pressure limiting valve with a maximum pressure of 500kPa must be installed with this appliance.
- The inlet water pressure must be between 100 kPa and 500 kPa.
- If lower than 100 kPa, a pump shall be installed to the supply water.

Installation instructions

Electrical installation



WARNING

- Electrical connections must be carried out by a licensed, qualified professional.
- Always switch off power before connecting the electricity.
- Earthing must comply with local standards including AS/NZS3000.

- 1 . The installation, service, or repair of the electrical components of this appliance must be completed:
 - a. by a licensed, qualified trades person.
 - b. in accordance with all local codes and regulations and standards including AS/NZS 3000.
- 2 . Materials that are certified to local standards must be used in the installation of this appliance.
- 3 . The appliance must be reliably earthed.
- 4 . This appliance must be connected to a dedicated circuit. This circuit must be fitted with a circuit breaker that is no greater than 30A. It is recommended that a residual current device (RCD) is also fitted.
- 5 . The circuit to the appliance must be a minimum of a 2.5mm² 2-core plus earth cable.
- 6 . The earth and neutral wire of the power supply must be separated entirely. Connecting the neutral wire to the earth wire is not allowed.

Installation instructions

Plumbing installation

! Plumbing installations must comply to AS/NZS3500.4 and appropriate plumbing regulations in Australia and New Zealand.

FOR NEW ZEALAND INSTALLATIONS ONLY

The Plumbing and Drainage standard (AS/NZS 3500.4) requires all storage water heaters in New Zealand to be installed with seismic restraints to avoid damage or personal injury if a seismic event should occur.

To meet this requirement this appliance should be fitted with three stainless steel straps, 25mm wide x 1mm thick.

These straps should be fitted as per the following instructions:

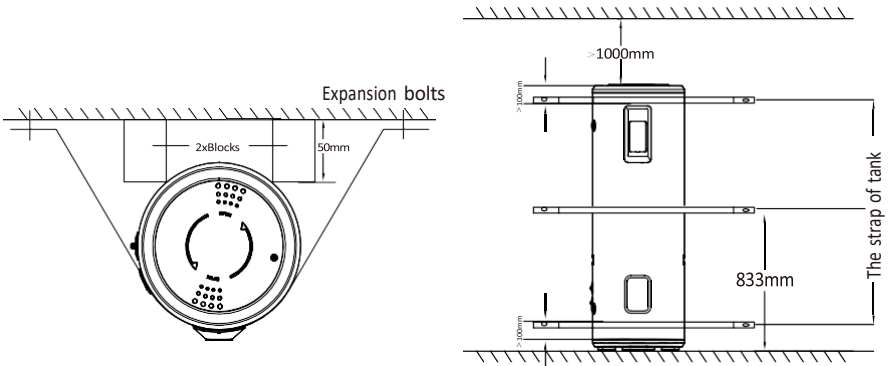

Installation instructions

Electrical connections

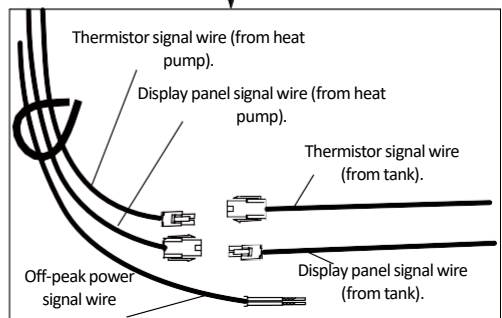
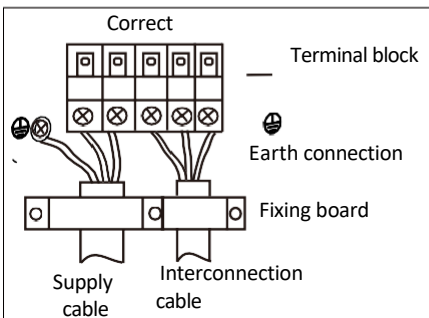
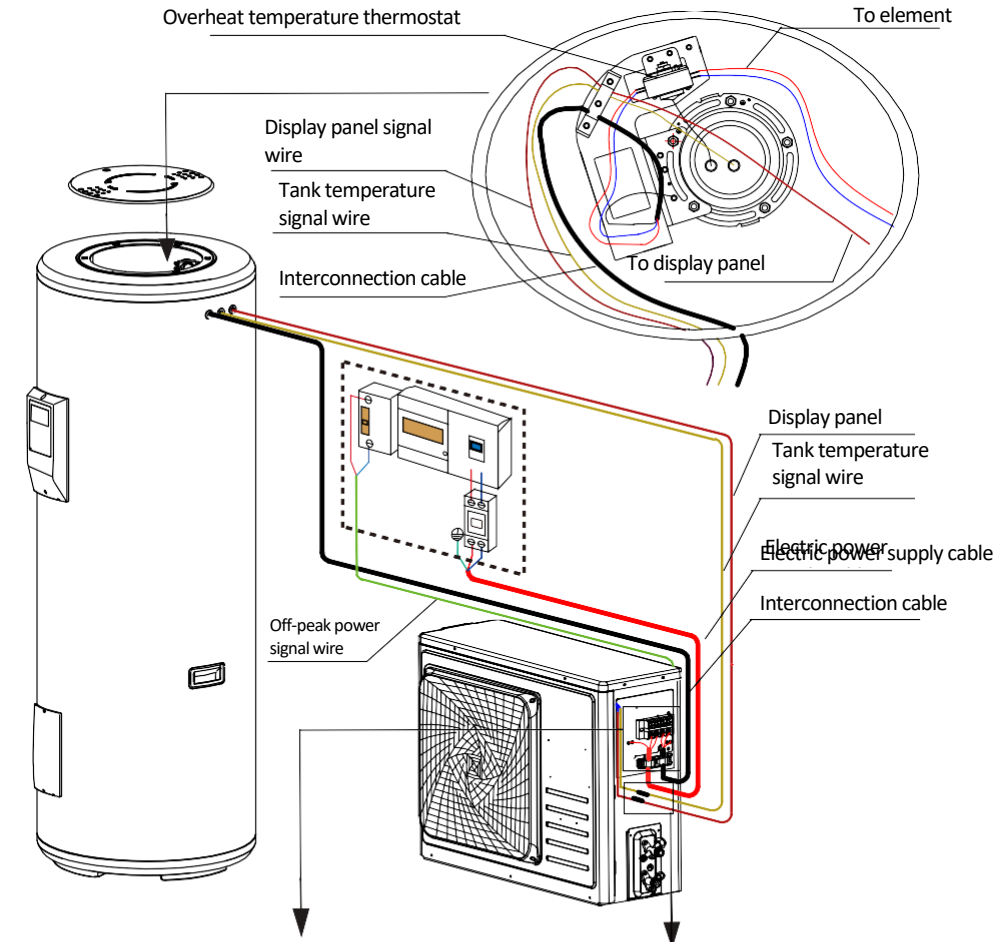

Installation instructions

Electrical connections

Connecting the cables and signal wires

- a) Remove the electric cover of tank unit and connect the Interconnection cable to the terminal block.
- b) Remove the electric cover of heat pump unit. Connect the supply cable and interconnection cable according to the wiring diagrams.
- c) Connect the display panel signal wire, the tank temperature signal wire and off-peak power signal wire.
- d) After connection, supply and interconnection cables shall be secured by the cable clamp attached to the fixing board.
- e) Install the electric cover of heat pump unit.

Description	Availability
Supply cable	supplied
Interconnection cable	supplied
Off-peak power signal wire	supplied
Tank temperature signal wire	supplied
Display panel signal wire	supplied

Commissioning

Installers shall use the following check list for trial operation of water heaters.

- Electrical wires are securely connected?
- Water connections are fitted correctly?
- The appliance is earthed correctly.
- The user control on the cylinder is functional.
- All noises are normal.
- The PTR valve supplied with the appliance has been fitted?
- All fittings and materials used in conjunction with this appliance are compliant with local standards and have been installed for their intended use?
- The cylinder has been filled with water, and the hot water lines of the home have been purged of air bubbles?
- After the water pipe of the water system is filled, check the whole water pipeline. There is no leakage?
- After the water system is filled with water, is there water flowing out after the pressure is relieved via the automatic safe pressure PTR Valve?
- After the water system is filled with water and successfully tested, all outdoor water pipework should be fitted with an approved insulation material?
- Has the drain valve and drainpipe, and the PTR valve and drain pipe been connect to or over an appropriate drainage point?

Installation instructions

Wiring diagram

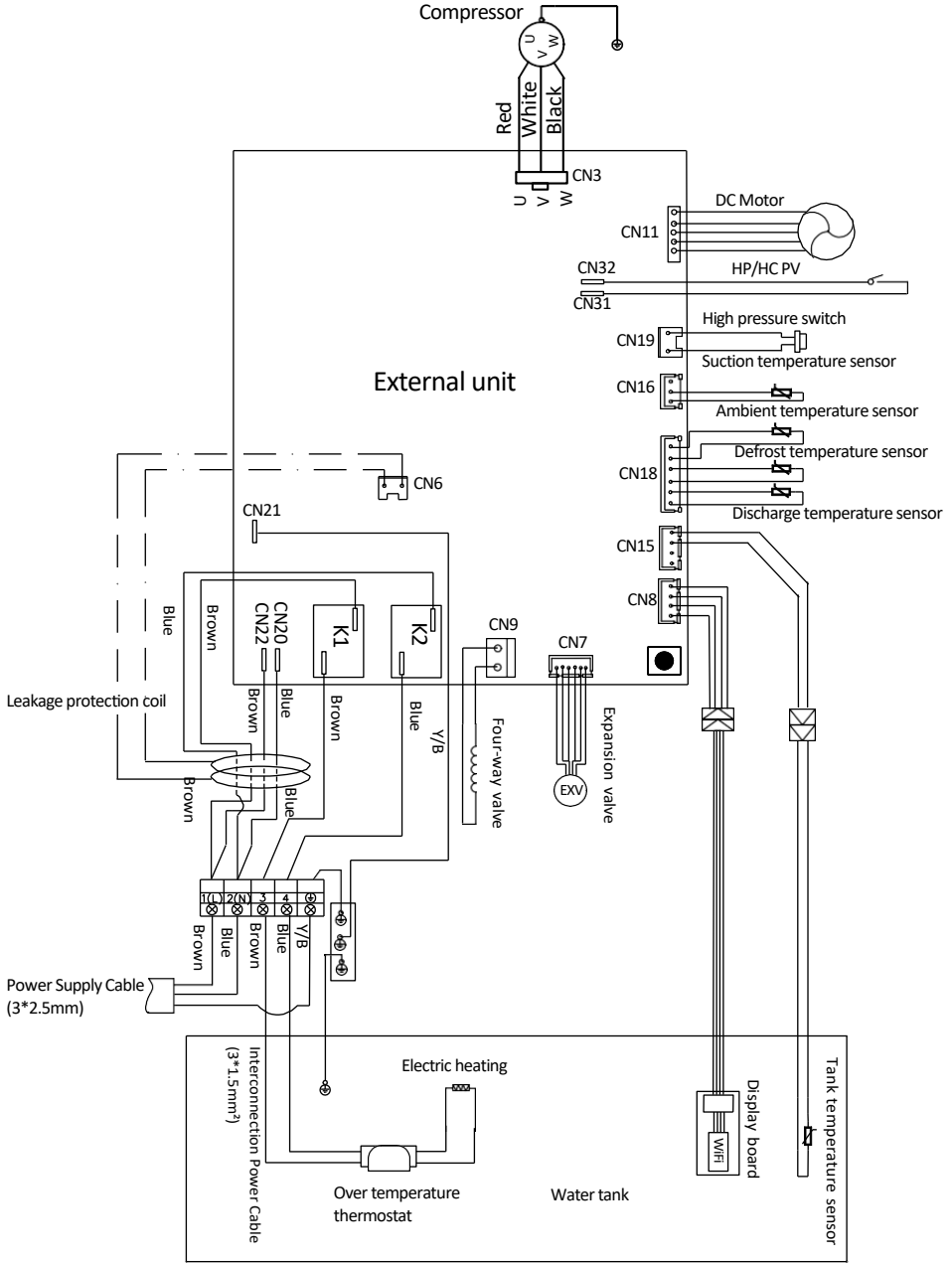

Operation and functions







Display









Description of the icons

Symbol	Description
	Power ON/OFF switch
MODE	Working mode selection
SET	Confirm the selection
TIMER	Timer adjustment
BOOST	Boost mode. Uses electrical element and heat pump for quicker heating.

Operation and functions

Symbol	Description
	<p><u>Auto mode</u></p> <ul style="list-style-type: none"> -Optimized management of the heat pump and backup element for guaranteed comfort. - The compressor maximum continuous working time (\overline{t}_{cc}) can be adjusted in the installer settings.
	<p><u>ECO (off-peak) mode</u></p> <ul style="list-style-type: none"> - In this mode, turn on the unit to provide hot water only during the off-peak power period. When the working time of the heat pump exceeds the default time, the auxiliary heat is started, and the heat pump stops.
	<p><u>Electric heating mode</u></p> <ul style="list-style-type: none"> - In this mode, the backup element is used as the only heat source. - This function ensures hot water supply when the heat pump is not working properly.
	<p><u>Vacation mode.</u></p> <ul style="list-style-type: none"> - Maintains a minimum temperature to prevent freezing, then heats to the set temperature for the owners return. Set by number of days by the owner.
	<p><u>Boost mode.</u> Backup element heating on for a faster time.</p>
	<p>Indication that the heat pump is operating.</p>
	<p>Indication that the backup element is operating.</p>





Operation and functions

Symbol	Description
	<p>When the PV function is on.</p> <p>When the appliance receives the signal for 5 minutes, the "PV" icon lights up.</p> <p>Indication that the appliance is receiving a signal that Solar PV generated energy is available. This will allow the appliance to operate according to the pre-set PV settings in the service menu.</p>
	<p>Time of peak/off-peak hours. In Time of peak/off-peak hours mode, the symbol corresponding to the mode is displayed. When receiving the signal, "HC" icon lights up.</p>
	<p><u>Anti-legionella</u></p> <p>-Anti-legionella function will be activated every 7 days to heat the tank to 61°C automatically.</p>
	<p>Hot water volume display.</p>
	<p>Wi-Fi signal icon.</p>
	<p><u>Lock screen display icon.</u></p> <ol style="list-style-type: none"> 1. Enter: In the power-on state, press and hold TIMER+BOOST (combination key) for 6s at the same time, the lock sign will be on, and the screen lock mode will be turned on. 2. After the screen lock mode is turned on, the device will not respond when the user touches any key. 3. Exit: press and hold TIMER+BOOST (combination key) for 6s at the same time, the lock sign is closed, and the screen lock mode is exited.

Note: Under certain conditions, ECO mode may result in shortages of hot water if ambient air temperatures are low.

Operation and functions

Installer settings

- To open the installer settings, press  switch off the system, then press  and **SET** at the same time for 10 seconds.
- When menu is open, press  or  to change the value of the settings.
- Press **SET** to confirm the settings.
- Press  to close the menu.



Parameters	Description	Factory setting	Adjustment range
LL NO, NC	<u>Off-peak signal type</u> When you use off-peak time clock control, first determine the type of signals, Only allow professional installers to operate. - NO corresponds to Normally Open Signal. - NC corresponds to Normally Close Signal.	NO	NO, NC
LP 01, 02 03	<u>Off-peak logic type</u> - In two ways using heat pump, should set in the installer settings -01 manually set off-peak time; -02 switch signals by power companies. -03 PV signal	01	01, 02, 03
LA ON, OFF	<u>PV function can be executed in AUTO mode (03 is selected in LP)</u> - ON corresponds to turned on PV function. - OFF corresponds to turned off PV function.	ON	ON, OFF
Lb 65-75	<u>Temperature setting in PV function (03 is selected in LP)</u> -The temperature setting is adjustable between 65°C and 75°C.	65	65-75
LC 01, 02 03	<u>Heat source selection in PV function (03 is selected in LP)</u> -01 Compressor and electric heating work at the same time. -02 The compressor shall be started first. When the system does not meet the operating conditions, the electric heating can be started. -03 Only electric heating is operated.	01	01, 02, 03
AL ON, OFF	<u>Avoid Legionella</u> - This parameter is used to activate the legionella protection mode. - Once every 7or (1-7) days, all domestic hot water is heated to 60°C~75°C.	ON	ON, OFF
AH 60-75	<u>Anti-Legionella temperature setting</u> - The Avoid Legionella temperature is adjustable between 60°C and 75°C.	61	60-75
Ad 01-07	<u>The frequency of Anti-legionella</u> - The frequency of Anti-legionella is adjustable, 7 days or (1-7) days are optional.	07	07,01-07

Operation and functions

Parameters	Description	Factory setting	Adjustment range
AA 3 42	<p>Compressor maximum continuous working time</p> <p>- If the maximum continuous working time of the compressor more than Set Time, start auxiliary power.</p>	8h	3h-12h
DE d1 d7	<p>Set the day of the week.</p> <p>- Set the day of the week, d1 to d7 for Monday to Sunday.</p>	/	d1-d7
BE 5-15	<p>Return differential temperature setting.</p> <p>- Set at 11°C for the 280L, meaning heating will start when the actual temperature drops 11°C below the set temperature. The adjustment range is 5°C-15°C.</p>	11	5-15

WIFI connection

Your appliance can be connected to your home wireless network and operated remotely using the app. Getting started:

1. Ensure your home Wi-Fi network is turned on,
2. Ensure the appliance is connected to power with the isolator switched. Power should be supplied and the appliance switched off. The display will indicate show the actual temperature reading of the water inside the appliance.
3. Press and hold " - " to enter the distribution network status. At this time, the WIFI icon () will flash. If the connection is successful the WIFI icon () will always be on. If the connection is not successful, the WIFI icon () will always be flashing.
4. It may take up to 10 minutes to connect your appliance.





On your mobile device:

1. Download the app from www.fisherpaykel.com/connect
2. Register and create an account.
3. Add your appliance and set up the Wi-Fi connection.



The  symbol on the product or on its packaging indicates that this product is not to be treated as regular household waste. Instead, it must be taken to a recycling collection point for electrical and electronic equipment. By properly disposing of this product, you are contributing to the preservation of the environment and the wellbeing of your fellow citizens. Improper disposal is hazardous to health and environment. You can obtain further information on how to recycle this product from your municipality, your waste management service or the shop where you purchased it.

Precautions for flammable refrigerant

	Since the flammable refrigerants are used, please read the following.
1	For Installation, maintenance and repair, and decommissioning.
	 <p>Service indicator; read technical manual.</p>  <p>Warning; low burning velocity material.</p>  <p>Operator's manual; operating instructions.</p>  <p>Read operator's manual.</p> <p>WARNING Do not use any means to accelerate the defrosting process or to clean the appliance other than those recommended by the manufacturer. The appliance shall be stored in a room without continuously operating ignition sources (for example: open flames, an operating gas appliance or an operating electric heater). Do not pierce or burn. Be aware that refrigerants may not contain an odour.</p>
2	For Installation, maintenance and repair, and decommissioning.
	<ul style="list-style-type: none"> • that the installation of pipework shall be kept to a minimum. • that compliance with national gas regulations shall be observed. • that mechanical connections made at Joints that made in the installation between parts of the refrigerating system shall be accessible for maintenance purposes. <p>– the maximum refrigerant charge for a 5m refrigerant length is 0.93 kg.</p> <p>– Since the flammable refrigerants are used, handling, installation, cleaning, servicing and disposal of refrigerant must comply with local regulations and this manual.</p> <p>– Warning: Installation and servicing shall be performed only as recommended by the manufacturer.</p>
3	For Installation, maintenance and repair, and decommissioning.
	<p>Warning: Only correctly qualified personnel shall carry out maintenance, service and repair operations.</p> <p>Examples for such working procedures are:</p> <ul style="list-style-type: none"> • breaking into the refrigerating circuit. • opening sealed components. • opening ventilated enclosures. <p>The competent persons are trained by the national training organisations or manufacturers that are accredited to teach the relevant national competency standards that may be set in legislation. The installation should be documented by a certificate.</p>

Precautions for flammable refrigerant

4	<p>For maintenance and repair, and decommissioning.</p>
	<p>Prior to beginning work on systems, safety checks are necessary to ensure that the risk of ignition is minimised. For repair to the refrigerating system, the following directions shall be understood prior to conducting work on the system.</p> <ul style="list-style-type: none"> • Work procedure. <p>Work shall be undertaken under a controlled procedure to minimise the risk of a flammable gas or vapor being present while the work is being performed.</p> <ul style="list-style-type: none"> • General work area <p>All maintenance staff and others working in the local area shall be instructed on the nature of work being carried out. Work in confined spaces shall be avoided.</p> <ul style="list-style-type: none"> • Checking for presence of refrigerant <p>The area shall be checked with an appropriate refrigerant detector prior to and during work, to ensure the technician is aware of the flammability potential of the refrigerant. Ensure that the leak detection equipment being used is suitable for use with all applicable refrigerants,</p> <p>i.e. non-sparking, adequately sealed or intrinsically safe.</p> <ul style="list-style-type: none"> • Presence of fire extinguisher <p>If any hot work is to be conducted on the refrigerating equipment or any associated parts, appropriate fire extinguishing equipment shall be available to hand. Have a dry powder or CO2 fire extinguisher adjacent to the charging area.</p> <ul style="list-style-type: none"> • No ignition sources. <p>No person carrying out work in relation to a refrigerating system which involves exposing any pipe work shall use any sources of ignition in such a manner that it may lead to the risk of fire or explosion. All possible ignition sources, including cigarette smoking, should be kept sufficiently far away from the site of installation, repairing, removing and disposal, during which refrigerant can possibly be released to the surrounding space. Prior to work taking place, the area around the equipment is to be surveyed to make sure that there are no flammable hazards or ignition risks.</p> <ul style="list-style-type: none"> • “No Smoking” signs shall be displayed. • Ventilated area: Ensure that the area is in the open or that it is adequately ventilated before breaking into the system or conducting any hot work. An appropriate level of ventilation must be made while work is carried out. The ventilation should safely disperse any released refrigerant and preferably expel it outdoors. • Checks to the refrigerating equipment. <p>Where electrical components are being changed, they shall be fit for the purpose and to the correct specification. At all times the manufacturer’s maintenance and service guidelines shall be followed. If in doubt, consult the manufacturer’s technical department for assistance.</p> <p>The following checks shall be applied to installations using flammable refrigerants:</p> <ul style="list-style-type: none"> – the actual refrigerant charge is in accordance with the manual, max. 0.93kg. – markings to the equipment continues to be visible and legible. Markings and signs that are illegible shall be corrected.

Precautions for flammable refrigerant

	<p>– refrigerating pipe or components are installed in a position where they are unlikely to be exposed to any substance which may corrode refrigerant containing components, unless the components are constructed of materials which are inherently resistant to being corroded or are suitably protected against being so corroded.</p> <ul style="list-style-type: none"> • Checks to electrical devices. <p>Repair and maintenance to electrical components shall include initial safety checks and component inspection procedures. If a fault exists that could compromise safety, then no electrical supply shall be connected to the circuit until it is satisfactorily dealt with. If the fault cannot be corrected immediately but it is necessary to continue operation, an adequate temporary solution shall be used. This shall be reported to the owner of the equipment so all parties are advised.</p> <p>Initial safety checks shall include:</p> <ul style="list-style-type: none"> – that capacitors are discharged: this shall be done in a safe manner to avoid possibility of sparking. – that no live electrical components and wiring are exposed while charging, recovering or purging the system. – that there is continuity of earth bonding.
5	<p>For maintenance and repair.</p>
	<ul style="list-style-type: none"> • Repairs to sealed components <p>– During repairs to sealed components, all electrical supplies shall be disconnected from the equipment being worked upon prior to any removal of sealed covers, etc. If it is absolutely necessary to have an electrical supply to equipment during servicing, then a permanently operating form of leak detection shall be located at the most critical point to warn of a potentially hazardous situation.</p> <p>– Particular attention shall be paid to the following to ensure that by working on electrical components, the casing is not altered in such a way that the level of protection is affected. This shall include damage to cables, excessive number of connections, terminals not made to original specification, damage to seals, incorrect fitting of glands, etc.</p> <p>Ensure that the apparatus is mounted securely.</p> <p>Ensure that seals or sealing materials have not degraded to the point that they no longer serve the purpose of preventing the ingress of flammable atmospheres. Replacement parts shall be in accordance with the manufacturer’s specifications.</p> <ul style="list-style-type: none"> • Repair to intrinsically safe components. <p>Do not apply any permanent inductive or capacitance loads to the circuit without ensuring that this will not exceed the permissible voltage and current permitted for the equipment in use.</p> <p>Intrinsically safe components are the only types that can be worked on while live in the presence of a flammable atmosphere. The test apparatus shall be at the correct rating. Replace components only with parts specified by the manufacturer. Other parts may result in the ignition of refrigerant in the atmosphere from a leak.</p> <p>The use of silicon sealant can inhibit the effectiveness of some types of leak detection equipment.</p> <p>Intrinsically safe components do not have to be isolated prior to working on them.</p>

Precautions for flammable refrigerant

6	For Installation, Maintenance and repair.
	Cabling: Check that cabling will not be subject to wear, corrosion, excessive pressure, vibration, sharp edges or any other adverse environmental effects. The check shall consider the effects of aging or continual vibration from the compressors or fans.
7	For Installation, Maintenance and repair, and Decommissioning.
	<p>Detection of flammable refrigerants</p> <p>Under no circumstances shall potential sources of ignition be used in the searching for or detection of refrigerant leaks. A halide torch (or any other detector using a naked flame) shall not be used.</p> <p>The following leak detection methods are deemed acceptable for all refrigerant systems.</p> <p>Electronic leak detectors may be used to detect refrigerant leaks but, in the case of flammable refrigerants, the sensitivity may not be adequate, or may need re-calibration.</p> <p>(Detection equipment shall be calibrated in a refrigerant-free area). Ensure that the detector is not a potential source of ignition and is suitable for the refrigerant used. Leak detection equipment shall be set at a percentage of the LFL of the refrigerant and shall be calibrated to the refrigerant employed, and the appropriate percentage of gas (25 % maximum) is confirmed. Leak detection fluids are also suitable for use with most refrigerants but the use of chlorine and caustic chemicals must be avoided as they may react with the refrigerant and corrode the copper pipework.</p> <p>NOTE Examples of leak detection fluids are.</p> <ul style="list-style-type: none"> – bubble method, – fluorescent method agents. <p>If a leak is suspected, all naked flames or ignition sources must be removed or extinguished. If a leakage of refrigerant is found which requires brazing, all of the refrigerant shall be Recovered from the system, or isolated (by means of shut off valves) in a part of the system remote from the leak. Removal of refrigerant shall be according to Removal and evacuation procedure in this manual.</p>
8	For Installation, Maintenance and repair, and Decommissioning.
	<p>Removal and evacuation</p> <p>When breaking into the refrigerant circuit to make repairs – or for any other purpose – conventional procedures shall be used. However, for flammable refrigerants it is important that best practice is followed since flammability is a major consideration. The following procedure shall be adhered to:</p> <ul style="list-style-type: none"> • remove refrigerant. • purge the circuit with inert gas (optional). • evacuate (optional). • purge with inert gas (optional). • open the circuit by cutting or brazing. <p>The refrigerant charge shall be recovered into the correct recovery cylinders.</p> <p>If the purging the circuit with inert gas, evacuate and purge the system with oxygen free nitrogen to render the appliance safe for flammable refrigerants.</p>

	<p>This process may need to be repeated several times. Compressed air or oxygen shall not be used for purging refrigerant systems. Refrigerant purging can be achieved by breaking the vacuum in the system with oxygen-free nitrogen and continuing to fill until the working pressure is achieved, then venting to atmosphere, and finally pulling down to a vacuum. This process shall be repeated until no refrigerant is within the system. When the final oxygen-free nitrogen charge is used, the system shall be vented down to atmospheric pressure to enable work to take place. This operation is absolutely vital if brazing operations on the pipe-work are to take place. Ensure that the outlet for the vacuum pump is not close to any potential ignition sources and that ventilation is available.</p>
9	For Installation and Maintenance and repair.
	<p>Charging procedures In addition to conventional charging procedures, the following requirements shall be followed.</p> <ul style="list-style-type: none"> • Ensure that contamination of different refrigerants does not occur when using charging equipment. Hoses or lines shall be as short as possible to minimise the amount of refrigerant contained in them. • Cylinders shall be kept in an appropriate position according to the instructions. • Ensure that the refrigerating system is earthed prior to charging the system with refrigerant. • Label the system when charging is complete (if not already). • Extreme care shall be taken not to overfill the refrigerating system. <p>Prior to recharging the system, it shall be pressure-tested with the appropriate purging gas. The system shall be leak-tested on completion of charging but prior to commissioning. A follow up leak test shall be carried out prior to leaving the site.</p>
10	For Decommissioning.
	<p>Decommissioning Before carrying out this procedure, it is essential that the technician is completely familiar with the equipment and all its detail. It is recommended good practice that all refrigerants are recovered safely. Prior to the task being carried out, an oil and refrigerant sample shall be taken in case analysis is required prior to re-use of recovered refrigerant. It is essential that electrical power is available before the task is commenced.</p> <ol style="list-style-type: none"> a) Become familiar with the equipment and its operation. b) Isolate system electrically. c) Before attempting the procedure, ensure that: <ul style="list-style-type: none"> • mechanical handling equipment is available, if required, for handling refrigerant cylinders. • all personal protective equipment is available and being used correctly. • the recovery process is supervised at all times by a competent person. • recovery equipment and cylinders conform to the appropriate standards. d) Pump down refrigerant system, if possible.

Precautions for flammable refrigerant

	<p>e) If a vacuum is not possible, make a manifold so that refrigerant can be removed from various parts of the system.</p> <p>f) Make sure that the cylinder is situated on the scales before recovery takes place.</p> <p>g) Start the recovery machine and operate in accordance with instructions.</p> <p>h) Do not overfill cylinders (no more than 80 % volume liquid charge).</p> <p>i) Do not exceed the maximum working pressure of the cylinder, even temporarily.</p> <p>j) When the cylinders have been filled correctly and the process completed, make sure that the cylinders and the equipment are removed from site promptly and all isolation valves on the equipment are closed off.</p> <p>k) Recovered refrigerant shall not be charged into another refrigerating system unless it has been cleaned and checked.</p>
11	For Decommissioning.
	<p>Labelling</p> <p>Equipment shall be labelled stating that it has been de-commissioned and emptied of refrigerant. The label shall be dated and signed. For appliances containing flammable refrigerants, ensure that there are labels on the equipment stating the equipment contains flammable refrigerant.</p>
12	For Installation, Maintenance and repair, and Decommissioning.
	<p>Recovery of refrigerant</p> <p>When removing refrigerant from a system, either for servicing or decommissioning, it is recommended good practice that all refrigerants are removed safely.</p> <p>When transferring refrigerant into cylinders, ensure that only appropriate refrigerant recovery cylinders are used. Ensure that the correct number of cylinders for holding the total system charge is available. All cylinders to be used are designated for the recovered refrigerant and labelled for that refrigerant (i.e. special cylinders for the recovery of refrigerant). Cylinders shall have pressure-relief and shut-off valves in good working order. Empty recovery cylinders are evacuated and, if possible, cooled before recovery occurs.</p> <p>The recovery equipment shall be in good working order with a set of instructions concerning the equipment that is at hand and shall be suitable for the recovery of all appropriate refrigerants including, when applicable, flammable refrigerants. In addition, a set of calibrated weighing scales shall be available and in good working order. Hoses shall be complete with leak-free disconnect couplings and in good condition. Before using the recovery machine, check that it is in satisfactory working order, has been properly maintained and that any associated electrical components are sealed to prevent ignition in the event of a refrigerant release. Consult manufacturer if in doubt. The recovered refrigerant shall be returned to the refrigerant supplier in the correct recovery cylinder, and the relevant waste transfer note arranged. Do not mix refrigerants in recovery units and especially not in cylinders.</p> <p>If compressors or compressor oils are removed, ensure that they have been evacuated to an acceptable level to make certain that flammable refrigerant does not remain within the lubricant. The evacuation process shall be carried out prior to returning the compressor to the suppliers. Only electric heating to the compressor body shall be employed to accelerate this process. When oil is drained from a system, it shall be carried out safely.</p>

Checking and maintenance



- Installation and maintenance of the appliance must be done by a qualified professional.
- Before working on the appliance, shut down the machine and isolate the power supply at the switch.
- Do not touch with wet hands.
- Maintenance operations are important to guarantee optimum performance and extend the life of the appliance.

Checking the PTR valve

- Operate the PTR valve at least once every six months to ensure it is functioning correctly. If the valve fails to release water when the lever is activated, check for blockages. If none exist, call Haier Customer Care or a qualified professional to resolve the issue and check the water pipework.

Checking the pipework

- Check the watertightness of the water connections.

Cleaning the fan

- The fan should be checked for dust annually. If cleaning is required call Haier Customer Service or a qualified professional.
- Checking and cleaning the evaporator must be completed by a qualified professional.

Checking the evaporator



- The evaporator fins are sharp and are a potential injury risk.
- Avoid damaging the evaporator fins as this can affect the performance of the appliance.

- It is recommended that the evaporator is cleaned every two years.
- Clean the evaporator with a soft brush and water if required. Do not use cleaners on the evaporator fins.

Checking the condensate drain

Check the condensate drain for blockages as they have the potential to flood the appliance.

Checking the Anode

- Checking and replacing the anode must be carried out by a qualified professional.
- To avoid irreversible corrosion of the cylinder, it is recommended to check the anode every five years and replaced if required.

Faults and protection

Water Quality

A breach of this condition may void the warranty in the event of damage caused by water quality exceeding these characteristics.

Water supply from an unfiltered water source that may be highly conductive or have a high mineral content may void the system warranty.

The following characteristics should not be exceeded in order for the warranty to be conditions not to be breached.

Water Properties	Acceptable Level
Total hardness	Up to 200 mg/litre or ppm
Total Dissolved Solids (TDS)	Up to 600 mg/litre or ppm
Chloride	Up to 250 mg/litre or ppm
Magnesium	Up to 10 mg/litre or ppm
Sodium	Up to 150 mg/litre or ppm
pH	Between Min 6.5 to Max 8.5
Electricity conductivity	Up to 850 μ S/cm

In areas of poor water quality, it is recommended that a softener, conditioner or similar device be fitted to the water supply.

Faults and protection

Fault type	Action	Digital indication	Release
Communication fault	Communication failure between Wi-Fi module and control board	F0	Please call Haier Customer Service to resolve the issue
Compressor protection	Operating temperature protection	F2	After fault is solved, switch on power supply for release
	Air exhaust temperature protection	F3	
	Evaporation high temperature protection	F5	
Electricity leakage alarming	The system will automatically cut off power supply if any line fault occurs	E1	
Over temperature alarming	The actual water temperature $\geq 90^{\circ}\text{C}$	E2	
Fault of the inner temperature sensor	If short circuit or circuit break occurs to the sensor	E3	
Fault of the ambient temperature sensor	If short circuit or circuit break occurs to the sensor	E4	
Fault of the evaporation temperature sensor	If short circuit or circuit break occurs to the sensor	E5	
Fault of the air exhaust temperature sensor	If short circuit or circuit break occurs to the sensor	E6	
Fault of the air intake temperature sensor	If short circuit or circuit break occurs to the sensor	ED	
Communication fault	Communication of main control panel and display panel is abnormal	E7	
Pressure switch protection	Action of the pressure switch at the exhaust outlet	E8	
Ambient temperature protection	Ambient or outdoor temperature $< -15^{\circ}\text{C}$ or $> 45^{\circ}\text{C}$	E9	
Fault of the Off-peak power switching signal	If not received the Off-peak signal when selecting switch signals by power companies	EF	
Fault of the fan	Fan blade is stuck or fan and control panel communication failure	L7	
Transient hardware over-current of the compressor phase current	The MCU detects a low-level input at the FO port or a bus current greater than the 19.4A peak threshold set by the MCU internal comparator	P1	Power on or off the device again. The fault is rectified
Compressor phase current software transient overcurrent	The instantaneous output current is greater than 17A	P2	When the current is less than the set protection value, the system automatically recovers after 20s

Faults and protection

Fault type	Action	Digital indication	Release
The heat sink (IPM) temperature is too high	IPM module temperature > 100 ° C	P3	60 seconds later, the MCU detects that the IPM module temperature is lower than 85 ° C and automatically recovers
Input overflow load	The input current RMS exceeds 18A or the peak output current exceeds 17A	P4	The compressor automatically recovers after shutdown
Under voltage protection	Bus voltage below 200V lasts for 5ms	P5	If the VDC is greater than or equal to 210V after the compressor is stopped for 20 seconds, the fault is rectified
Over Voltage Protection	PFC voltage or bus voltage VDC greater than 390V for 5ms	P6	After the compressor is stopped for 20 seconds, the fault is rectified if the $VDC \leq 380V$
The communication between the main control chip and the driver chip is abnormal	The master control and driver cannot receive data or a data error persists for 2 minutes	P7	After receiving the communication from the other party, it automatically recovers and the fault is eliminated
The current detection on the frequency conversion side is abnormal	Before the compressor is in operation, there is a 10-20% deviation between the AD value of the incoming voltage detected by the sampling circuit and the AD value of 1.65V	P8	The circuit is repaired and then powered on again
Compressor out of step	The actual running speed of the compressor is less than 50% or more than 120% of the target speed of the drive for more than 5S	PB	Detect normal fault elimination
Instantaneous Software Overflow on the rectifier Side	The instantaneous value of the input current is greater than 30A for 3 times, and each PWM cycle is detected once	PD	After the compressor is stopped for 20 seconds, the current is less than 30A and automatically recovers. Power off and restart. The fault is rectified
Transient hardware over-current on the rectifier side	The instantaneous input current is greater than 31A for four times	PF	The compressor automatically recovers when the current is less than 31A after 20 seconds of shutdown. Power off and restart. The fault is rectified

Haier

Haier Appliances

Australia 1300 729 948 | haier.com.au

New Zealand 0800 424 372 | haier.co.nz

Fisher & Payke | **Australia Pty Ltd**, Level1, 1 Eden Park Drive, Macquarie Park, NSW 2113. Phone
Customer Care: 1300 729 948 Email: customer.care@haier.com.au

Fisher & Payke | **Appliances Ltd**, 78, Springs Road, East Tamaki, Auckland 2013.
Phone Customer Care: 0800 424 372. Email: customer.care@haier.co.nz

0040512570
20240419
√*****